

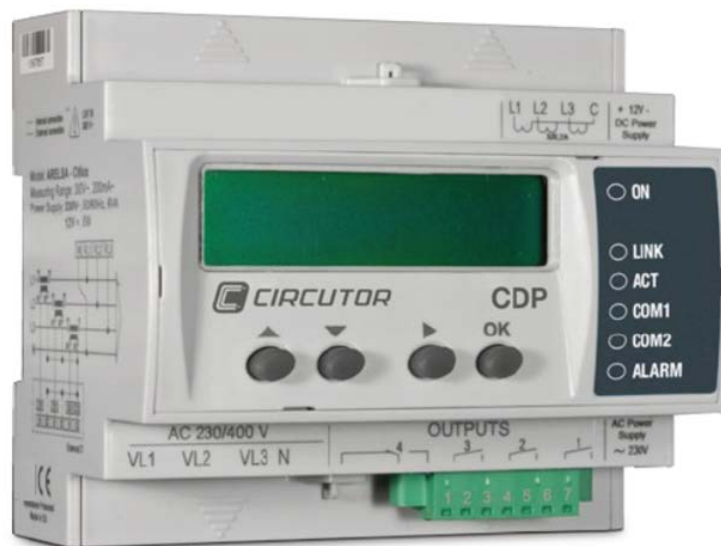

Connection and configuration of a CDP with DELTA-TR inverters





APPLICATION NOTES (M028E0101-03-15A)



SAFETY PRECAUTIONS

Follow the warnings described in this manual with the symbols shown below.

	<p>DANGER Warns of a risk, which could result in personal injury or material damage.</p>
---	---

	<p>ATTENTION Indicates that special attention should be paid to a specific point.</p>
---	--

If you must handle the unit for its installation, start-up or maintenance, the following should be taken into consideration:

	<p>Incorrect handling or installation of the unit may result in injury to personnel as well as damage to the unit. In particular, handling with voltage applied may result in electric shock, which may cause death or serious injury to personnel. Defective installation or maintenance may also lead to the risk of fire. Carefully read the manual prior to connecting the unit. Follow all installation and maintenance instructions throughout the unit's working life. Pay special attention to the installation standards of the National Electrical Code.</p>
---	--

	<p>Consult the instruction manual before using the unit In this manual, if the instructions marked with this symbol are not respected or followed correctly, it can result in injury or damage to the unit and /or installations.</p>
---	--

CIRCUTOR, SA reserves the right to modify features or the product manual without prior notification.

DISCLAIMER

CIRCUTOR, SA reserves the right to make modifications to the device or the unit specifications set out in this instruction manual without prior notice.

CIRCUTOR, SA, on its web site, supplies its customers with the latest versions of the device specifications and the most updated manuals.

www.circutor.com



CONTENTS

SAFETY PRECAUTIONS	3
DISCLAIMER	3
CONTENTS	4
LOG OF REVISIONS	5
1.- INTRODUCTION	6
2.- DELTA SOLIVIA INVERTER	6
2.1.- COMMUNICATION CABLE	6
2.1.1. CONNECTION OF ONE INVERTER.....	8
2.1.2. CONNECTION OF SEVERAL INVERTERS.....	8
2.2.- INVERTER COMMUNICATION CONFIGURATION	9
2.2.1. PERIPHERAL NUMBER CONFIGURATION.....	10
2.2.2. COMMUNICATION SPEED CONFIGURATION	10
3.- CDP CONFIGURATION	11
4.- COMMUNICATIONS TEST AND REGULATION	13
4.1.- COMMUNICATIONS TEST	13
4.2.- REGULATION TEST.....	14
5.- MAINTENANCE AND TECHNICAL SERVICE	15
6.- GUARANTEE	15

LOG OF REVISIONS

Table 1: Log of revisions.

Date	Revision	Description
09/14	M028E0101-03-14A	Original version
08/15	M028E0101-03-15A	Changes in the following sections: 2.1. – 2.2.1.

Note: The images of the units are solely for the purpose of illustration and may differ from the original unit.

1.- INTRODUCTION

DELTA offers several inverter models that can be managed via the **CDP Dynamic power controller**.

For the **CDP** controller to be able to correctly manage the inverter, communication between the two devices must be correct and both products must be correctly programmed.

	<p>These application notes are not meant as a substitute for the CDP or inverter manuals, but rather as additional support for individuals who need to interconnect the two devices.</p>
---	---

Even so, the guides and manuals of each product should be consulted and each company is responsible for providing technical support.

An inverter from the **SOLIVIA TR** family of inverters will be used as a model in these application notes.

2.- DELTA SOLIVIA INVERTER

The **CDP** and the inverter communicate via an RS-485 bus. This RS-485 bus can connect up to 100 inverters, although the number of inverters in the vast majority of domestic installations ranges from 1 to 3.

2.1.- COMMUNICATION CABLE

Functions of the communication cable terminals between the **CDP** and the inverter:

Table 2: Functions of the communication cable terminals.

CDP R2 channel communications connector		INVERTER Inverter connector (RJ45)	
Terminal	Description	Terminal	Description
5	GND	4	GND
1	A+	7	TX A
3	B-	8	RX B-

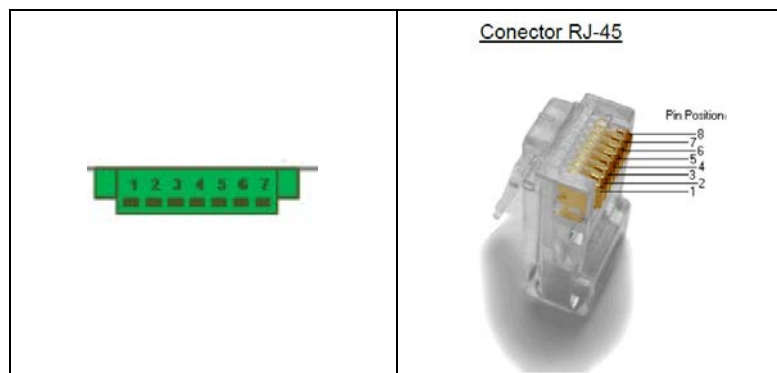

The cable must be connected to the RS-485 port of the inverter, number 3 in **Figure 1**. The inverter has two RS-485 ports and the communication cable can be connected to either one of them.

The unused RS-485 port should always have its connector covered.



- (1) Connections for PV modules
- (2) Grid connection
- (3) Interface connection RS485 (EIA485)
- (4) Display for status messages and keypad for operation
- (5) Light-emitting diodes for operational status display

Figure 1: Description of the inverter terminals.

2.1.1. CONNECTION OF ONE INVERTER

Figure 2 shows the connection between the **CDP** and a single inverter.

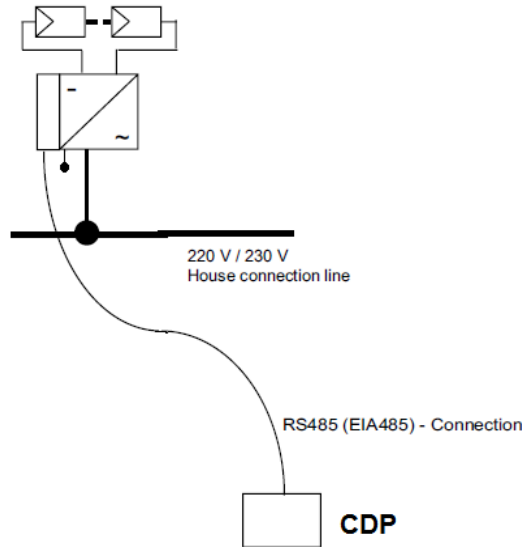

Figure 2: Connection between a CDP and one inverter.

2.1.2. CONNECTION OF SEVERAL INVERTERS

Figure 3 shows the connection between the **CDP** and several inverters.

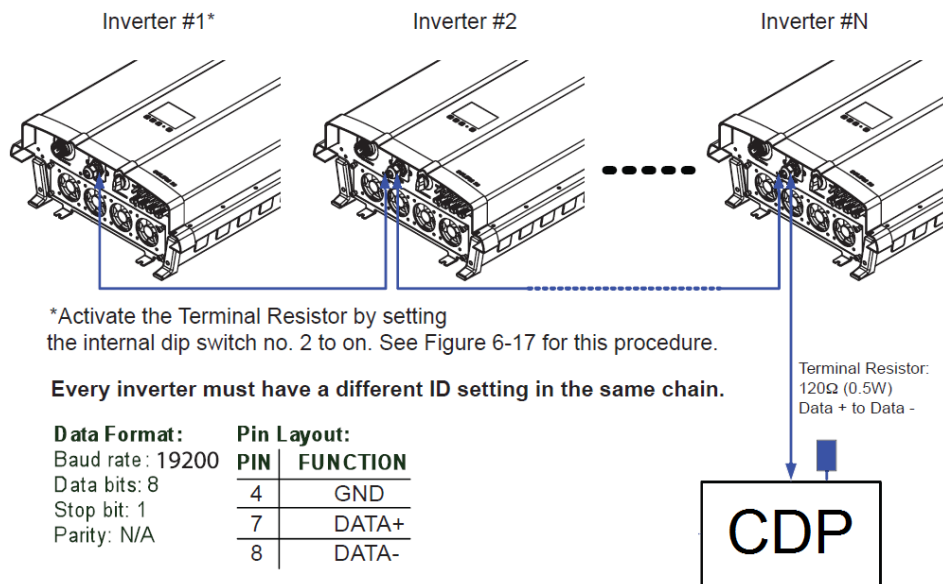
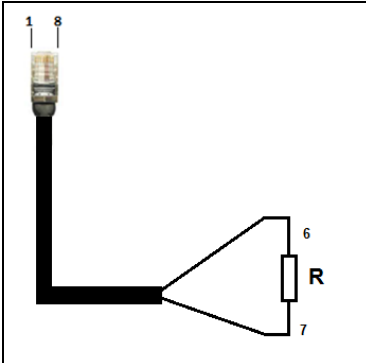

Figure 3: Connection between a CDP and several inverters.

The communication cable between the inverters is a pin-to-pin cable with RJ45 connectors on both ends. This type of cable can be purchased at any computer supply store as it is a common connector used for PCs and other devices with an Ethernet port.

The bus end terminal must always be connected to the last inverter of the RS-485 communication bus. This terminal has a 120 Ω resistor connected between pins 7 and 8 of the RJ45 connector. (Table 3)

Table 3: Bus end terminal.

	Connector PIN RJ45	Connection description
		1
	2	Not connected
	3	Not connected
	4	Not connected
	5	Not connected
	6	Not connected
	7	120 Ω resistor between pins 7 and 8
	8	

2.2.- INVERTER COMMUNICATION CONFIGURATION

The following describes how to use the display to configure the inverter for ensuring correct communication with the **CDP**.

	<p>The AC and DC sides of the inverter must be connected to the mains before it can turn on. Consult the inverter manual if you have any doubts.</p>
---	--

The configuration of the DELTA inverter parameters is done using the 4 buttons on the front panel of the unit. (Figure 4)

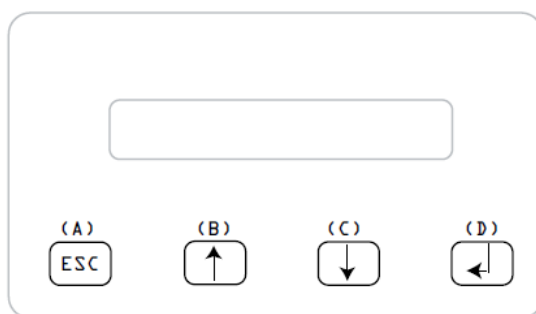

Key (A), ESC: To switch from the menu items to the main menu and to exit each sub-menu.

Key (B) and (C): For scrolling in the individual menu items and/or carrying out adjustments in the setup menu.

Key (D), ENTER: ENTER key for changing into the menu levels and for input acknowledgement in the setup menu.

Figure 4: DELTA inverter keyboard.

The parameters to be configured are:



- ✓ Peripheral number
- ✓ Communication speed

Both parameters are shown in the same setup menu of the inverter.

2.2.1. PERIPHERAL NUMBER CONFIGURATION

1. Go to the following path to change the peripheral number of the inverter:

Installation adjustments / RS485 / V.tran:

2. To program it correctly, use the arrow buttons until the "→" icon appears in the display next to the text "ID".
3. Press the  button to change this value. When the value starts flashing, use the arrow buttons to change the peripheral number to "1".
4. When the value "1" is displayed, press the  button again to confirm.

If there are several inverters, the devices must be numbered consecutively, beginning with the number 1.

In exceptional circumstances, if there are single-phase inverters in three-phase installations, they must be numbered as shown in **Table 4**:



Table 4: Peripheral number in three-phase installations with single-phase inverters.

Peripheral number		
Inverters L1	Inverters L2	Inverters L3
1 to 84	85 to 168	169 to 254

2.2.2. COMMUNICATION SPEED CONFIGURATION

1. To change the communication speed of the inverter, go to the following path:

Installation adjustments / RS485 / V.tran:

2. To program it correctly, use the arrow buttons until the "→" icon appears in the display next to the text "V.Tran".
3. Press the  button to change this value. When the value starts flashing, use the arrow buttons to scroll through the various options.
4. When the value "19200" is displayed, press the  button again to confirm.

To ensure correct communication, the inverter must have peripheral number 1 and the speed must be 19200 bps.

Check the communication between the inverter and the **CDP**, through the COM1 LED of the **CDP**:

- ✓ A flashing (or steady) LED means communication has been correctly

established.

The flashing rate is one flash per second (if there is one inverter) and 1/n if there are several inverters (where "n" is the number of inverters connected).

- ✓ If the COM1 LED is off, it means the **CDP** is not communicating with the inverter. In this case check the communication cables and the inverter communication configuration.

3.- CDP CONFIGURATION

There is a configuration web site for the **CDP** where all the parameters of the connected inverter have to be entered.

To do so, enter "/setup" at the end of the navigation bar where the **CDP** is monitoring so that the following, for example, appears in the navigation bar: **"10.0.110.212/setup"**

Next, the **CDP** configuration window will open (**Figure 5**).

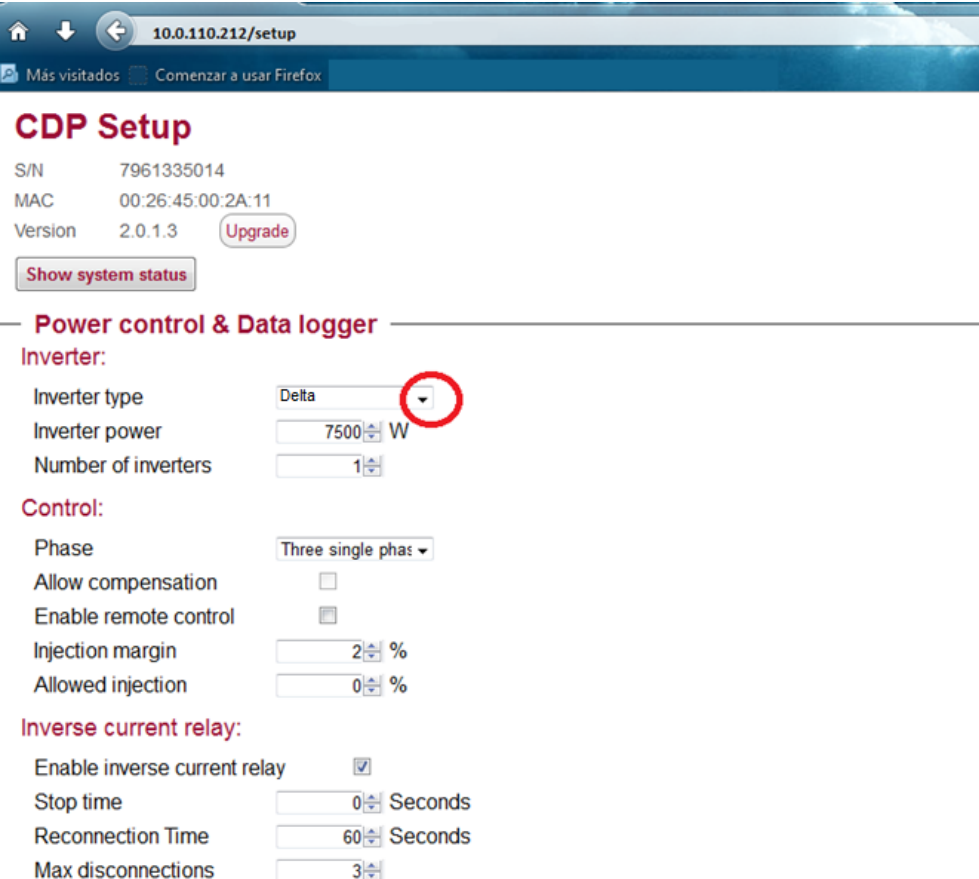

CDP Setup

S/N 7961335014
 MAC 00:26:45:00:2A:11
 Version 2.0.1.3 [Upgrade](#)
[Show system status](#)

Power control & Data logger

Inverter:

Inverter type 

Inverter power W

Number of inverters

Control:

Phase

Allow compensation

Enable remote control

Injection margin %

Allowed injection %

Inverse current relay:

Enable inverse current relay

Stop time Seconds

Reconnection Time Seconds

Max disconnections

Figure 5: CDP configuration web site.

The most important inverter parameters that have to be configured in the **CDP** are (**Table 5**):

Table 5: Parameters to be configured in the CDP.

Parameter	Description
Inverter type	Inverter model. In this case select: DELTA
Inverter power	Total power to be controlled by the CDP.
Number of inverters	Number of inverters to control.
Phase	Architecture of the inverter connections

	Consult the manual for more information on how to configure the CDP.
---	---

When working with several three-phase inverters in cascade, the sum of the power of all the inverters must be programmed in the ***Inverter Power*** variable in the **CDP** so that the same regulation percentage is sent to each one.

When working with single-phase inverters in three-phase installations, the total power of all the inverters must be programmed by selecting the "**three single phases**" option in the "**Phase**" variable, and then entering the number of sets of three single-phase inverters in the installation in the "**Number of inverters**" variable.

Example: If there are six 2 kW single-phase inverters (two on the L1 phase, two on the L2 phase and two on the L3 phase) the following configuration should be entered:

- ***Inverter power:*** 12000 W
- ***Number of inverters:*** 2
- ***Phase:*** three single phases

However, if there are three 2 kW single-phase inverters (one inverter per phase) the following configuration should be entered:

- ***Inverter power:*** 6000 W
- ***Number of inverters:*** 1
- ***Phase:*** three single phases

4.- COMMUNICATIONS TEST AND REGULATION

4.1.- COMMUNICATIONS TEST

Check the communication between the inverter and the **CDP**, through the COM1 LED of the **CDP**:

- ✓ A flashing (or steady) LED means communication has been correctly established.
The flashing rate is one flash per second (if there is one inverter) and 1/n if there are several inverters (where "n" is the number of inverters connected).
- ✓ If the COM1 LED is off, it means the **CDP** is not communicating with the inverter. In this case check the communication cables and the inverter communication configuration.

Correct communication between the **CDP** and the inverters connected to it can be checked on the configuration web site. To do so, press the "**Show system status**" button.

When this button is pressed, the **CDP** will scan the connected inverters and indicate how many of the total number of inverters that the CDP has been assigned to control have been detected.

The following image will appear if the communication is correct, **Figure 6**:

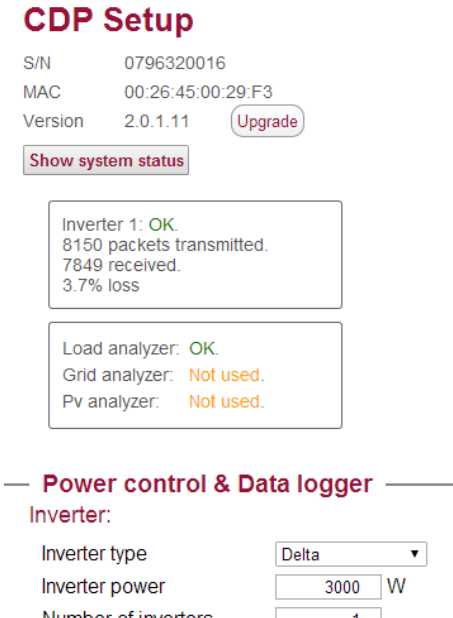

CDP Setup

S/N 0796320016
 MAC 00:26:45:00:29:F3
 Version 2.0.1.11 [Upgrade](#)

[Show system status](#)

Inverter 1: **OK**.
 8150 packets transmitted.
 7849 received.
 3.7% loss

Load analyzer: **OK**.
 Grid analyzer: **Not used**.
 Pv analyzer: **Not used**.

— **Power control & Data logger** —

Inverter:

Inverter type ▾
 Inverter power W
 Number of inverters

Figure 6: Checking communication between the CDP and the inverter.

4.2.- REGULATION TEST

The following test can be performed to ensure the **CDP** is correctly performing the regulation:

We assume a 3000W inverter generating 1400W.
We can see this value in the inverter display using the menu shown in **Figure 7**.

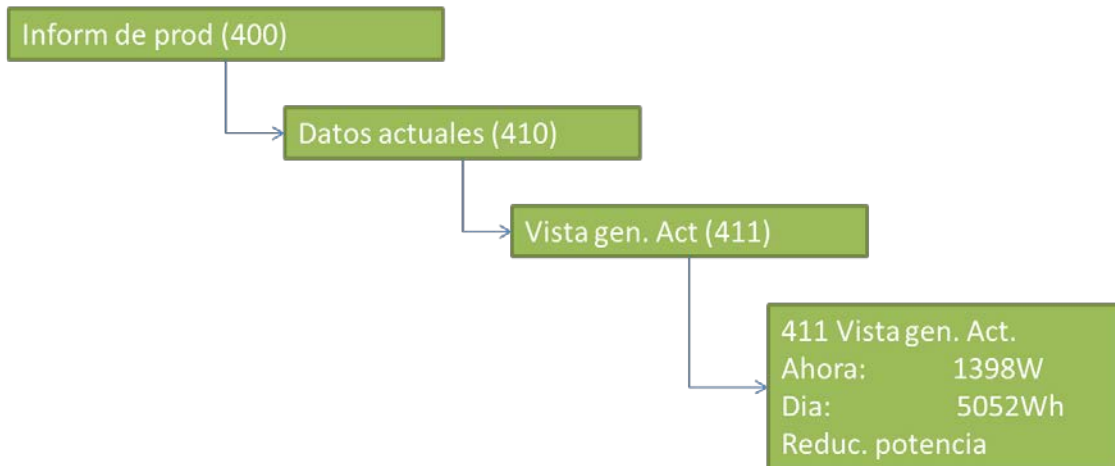



Figure 7: Display of the power generated by the inverter.

Now we program the **CDP** indicating that the inverter power is 6000W. The **CDP** will send the inverter a new setpoint so it can change its MPPT and the inverter will reduce photovoltaic generation by 50%, generating 700W.

	<p>Do not forget to reprogram the CDP with the initial inverter power value after completing the test.</p>
---	---

5.- MAINTENANCE AND TECHNICAL SERVICE

In the case of any query in relation to unit operation or malfunction, please contact the **CIRCUTOR, SA** Technical Assistance Service.

Technical Assistance Service

Vial Sant Jordi, s/n 08232 - Viladecavalls (Barcelona)

Tel.: 902 449 459 (Spain) / +34 937 452 900 (outside of Spain)

email: sat@circutor.es

6.- GUARANTEE

CIRCUTOR guarantees its products against any manufacturing defect for two years after the delivery of the unit.

CIRCUTOR will repair or replace any defective factory product returned during the guarantee period.

	<ul style="list-style-type: none"> • No returns will be accepted and no unit will be repaired or replaced if it is not accompanied by a report indicating the defect detected or the reason for the return. • The guarantee will be void if the unit has been improperly used or the storage, installation and maintenance instructions listed in this manual have not been followed. "Improper usage" is defined as any operating or storage condition contrary to the National Electrical Code or that surpassing the limits indicated in the technical and environmental features of this manual. • CIRCUTOR accepts no liability due to the possible damage to the unit or other parts of the installation, nor will it cover any possible sanctions derived from a possible failure, improper installation or "improper usage" of the unit. Consequently, this guarantee does not apply to failures occurring in the following cases: <ul style="list-style-type: none"> - Overvoltages and/or electrical disturbances in the supply; - Water, if the product does not have the appropriate IP classification; - Poor ventilation and/or excessive temperatures; - Improper installation and/or lack of maintenance; - Buyer repairs or modifications without the manufacturer's authorisation.
---	--

CIRCUTOR, SA

Vial Sant Jordi, s/n

08232 -Viladecavalls (Barcelona)

Tel.: (+34) 93 745 29 00 - Fax: (+34) 93 745 29 14

www.circutor.es central@circutor.es